



Integra, INT-12XX Power Measurement Digital Metering System Communications Guide

Contents

1	INTEGRA INT-12XX - Modbus™ Protocol Implementation	3
1.1	Modbus™ Protocol Overview	3
1.2	Modbus™ Protocol Input Registers	4
1.3	Modbus™ Protocol Holding Registers	5
2	RS485 General Information	6
2.1	Half Duplex	6
2.2	Connecting the Instruments	7
2.3	A and B terminals	7
2.4	Troubleshooting	8
3	MODBUS™ Protocol General Information	9
3.1	MODBUS™ Protocol Message Format	9
3.2	Serial Transmission Modes	10
3.3	MODBUS™ Protocol Message Timing (RTU Mode)	11
3.4	How Characters are Transmitted Serially	11
3.5	Error Checking Methods	12
3.5.1	Parity Checking	12
3.5.2	CRC Checking	12
3.6	Function Codes	13
3.7	IEEE floating point format	13
3.8	MODBUS™ Protocol Commands supported	14
3.9	Holding Registers	14
3.9.1	Read Holding Registers	14
3.9.2	Write Holding Registers	15
3.10	Exception Response	15
3.11	Exception Codes	16
3.11.1	Table of Exception Codes	16
4	APPENDIX 1 - INTEGRA, INT-12XX MODBUS™ Input Register Parameters	17
5	APPENDIX 2 - INTEGRA, INT-12XX MODBUS™ HOLDING Register Parameters	23

1 INTEGRA INT-12XX - Modbus™ Protocol Implementation

1.1 Modbus™ Protocol Overview

This section provides basic information for interfacing the Integra, INT-12XX power measurement meter to a Modbus™ Protocol network. If background information or more details of the Integra, INT-12XX implementation is required please refer to section 2 and 3 of this document.

The Integra, INT-12XX offers the option of an RS485 communication facility for direct connection to SCADA or other communications systems using the Modbus™ Protocol RTU slave protocol. The Modbus™ Protocol establishes the format for the master's query by placing into it the device address, a function code defining the requested action, any data to be sent, and an error checking field. The slave's response message is also constructed using Modbus™ Protocol. It contains fields confirming the action taken, any data to be returned, and an error-checking field. If an error occurs in receipt of the message, the Integra, INT-12XX will make no response. If the Integra, INT-12XX is unable to perform the requested action, it will construct an error message and send it as the response.

The electrical interface is 2-wire RS485, via 2 screw terminals. Connection should be made using twisted pair screened cable (Typically 22 gauge Belden 8761 or equivalent). All "A" and "B" connections are daisy chained together. The screens should also be connected to the "Gnd" terminal. To avoid the possibility of loop currents, an Earth connection should be made at only one point on the network.

Line topology may or may not require terminating loads depending on the type and length of cable used. Loop (ring) topology does not require any termination load.

The impedance of the termination load should match the impedance of the cable and be at both ends of the line. The cable should be terminated at each end with a 120 ohm (0.25 Watt min.) resistor.

A total maximum length of 3900 feet (1200 metres) is allowed for the RS485 network. A maximum of 32 electrical nodes can be connected, including the controller.

The address of each Integra, INT-12XX can be set to any value between 1 and 247.

The product also supports the broadcast address (00h); in this case all the devices connected to the bus will be written and none of them will send a response.

The minimum interval between the end of a response and the beginning of the next query (to the same device) is 150ms.

The minimum interval between the end of a response and the beginning of the next query (to a different device): 10ms.

Minimum response time-out (to be set on the master): 500ms.

The supervisory programme must allow this period of time to elapse before assuming that the Integra, INT-12XX power measurement meter is not going to respond.

The format for each byte in RTU mode is:

Coding System:	8-bit per byte
Data Format:	4 bytes (2 registers) per parameter. Floating point format (to IEEE 754) Most significant register first.
Error Check Field:	2 byte Cyclical Redundancy Check (CRC)
Framing:	1 start bit 8 data bits, least significant bit sent first 1 bit for even/odd parity (or no parity) 1 stop bit if parity is used; 2 bits if no parity

Data Coding

All data values in the Integra, INT-12XX are transferred as 32 bit IEEE 754 floating point numbers, (input and output) therefore each Integra, INT-12XX digital power measurement meters value is transferred using two MODBUS™ Protocol registers. All register read requests and data write requests must specify an even number of registers. Attempts to read/write an odd number of registers prompt the Integra, INT-12XX digital power meters to return a MODBUS™ Protocol exception message. However, for compatibility with some SCADA systems, Integra, INT-12XX digital power measurement meter will respond to any single input or holding register read with an instrument type specific value

The INTEGRA, INT-12XX can transfer a maximum of 50 values in a single transaction, therefore the maximum number of registers that can be requested is 100.

Data Transmission speed is selectable between 2400, 4800 9600, 19200 and 38400 baud.

1.2 Modbus™ Protocol Input Registers

Input registers are used to indicate the present values of the measured and calculated electrical quantities. Each parameter is held in two consecutive 16 bit registers. The following table details the 3X register address, and the values of the address bytes within the message. A tick (√) in the column indicates that the parameter is valid for the particular wiring system. Any parameter with a cross (X) will return the value Zero. Each parameter is held in the 3X registers. Modbus™ Protocol Function Code 04 is used to access all parameters.

For example, to request:-

Amps 1	Start address	= 0006
	No of registers	= 0002
Amps 2	Start address	= 0008
	No of registers	= 0002

Each request for data must be restricted to 50 parameters or less. Exceeding the 50 parameter limit will cause a Modbus™ Protocol exception code to be returned.

1.3 Modbus™ Protocol Holding Registers

Holding registers are used to store and display instrument configuration settings. All holding registers not listed in the table below should be considered as reserved for manufacturer use and no attempt should be made to modify their values.

The holding register parameters may be viewed or changed using the Modbus™ Protocol. Each parameter is held in two consecutive 4X registers. Modbus™ Protocol Function Code 03 is used to read the parameter and Function Code 16 is used to write. Write to only one parameter per message.

Writing operations MUST be preceded by writing the value 0000 0005h to the Write Enabled registers (40513 and 40514).

This remains enabled once the value is changed or the instrument is switched off.

Writing to registers without the above enable message will generate an exception response 01 "illegal function".

2 RS485 General Information

RS485 or EIA (Electronic Industries Association) RS485 is a balanced line, half-duplex transmission system allowing transmission distances of up to 1.2 km. The following table summarises the RS-485 Standard:

PARAMETER	
Mode of Operation	Differential
Number of Drivers and Receivers	32 Drivers, 32 Receivers
Maximum Cable Length	1200 m
Maximum Data Rate	10 M baud
Maximum Common Mode Voltage	12 V to -7 V
Minimum Driver Output Levels (Loaded)	+/- 1.5 V
Minimum Driver Output Levels (Unloaded)	+/- 6 V
Drive Load	Minimum 60 ohms
Driver Output Short Circuit Current Limit	150 mA to Gnd, 250 mA to 12 V 250 mA to -7 V
Minimum Receiver Input Resistance	12 kohms
Receiver Sensitivity	+/- 200 mV

Further information relating to RS485 may be obtained from either the EIA or the various RS485 device manufacturers, for example Texas Instruments or Maxim Semiconductors. This list is not exhaustive.

2.1 Half Duplex

Half duplex is a system in which one or more transmitters (talkers) can communicate with one or more receivers (listeners) with only one transmitter being active at any one time. For example, a "conversation" is started by asking a question, the person who has asked the question will then listen until he gets an answer or until he decides that the individual who was asked the question is not going to reply.

In a 485 network the "master" will start the "conversation" with a "query" addressed to a specific "slave", the "master" will then listen for the "slave's" response. If the "slave" does not respond within a pre-defined period, (set by control software in the "master"), the "master" will abandon the "conversation".

2.2 Connecting the Instruments

If connecting an RS485 network to a PC use caution if contemplating the use of an RS232 to 485 converter together with a USB to RS485 adapter. Consider either an RS232 to RS485 converter, connected directly to a suitable RS232 jack on the PC, or use a USB to RS485 converter or, for desktop PCs a suitable plug in RS485 card. *(Many 232:485 converters draw power from the RS232 socket. If using a USB to RS232 adapter, the adapter may not have enough power available to run the 232:485 converter.)*

Screened twisted pair cable should be used. For longer cable runs or noisier environments, use of a cable specifically designed for RS485 may be necessary to achieve optimum performance. All "A" terminals should be connected together using one conductor of the twisted pair cable, all "B" terminals should be connected together using the other conductor in the pair. The cable screen should be connected to the "Gnd" terminals.

A Belden 9841 (Single pair) or 9842 (Two pair) or similar cable with a characteristic impedance of 120 ohms is recommended. The cable should be terminated at each end with a 120 ohm, quarter watt (or greater) resistor. Note: Diagram shows wiring topology only. Always follow terminal identification on Integra, INT-12XX digital power measurement meter product label.

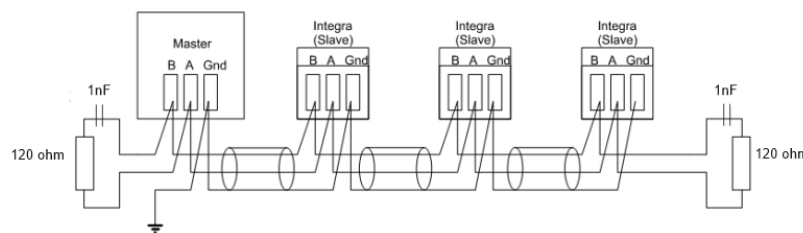

There must be no more than two wires connected to each terminal, this ensures that a "Daisy Chain or "straight line" configuration is used. A "Star" or a network with "Stubs (Tees)" is not recommended as reflections within the cable may result in data corruption.

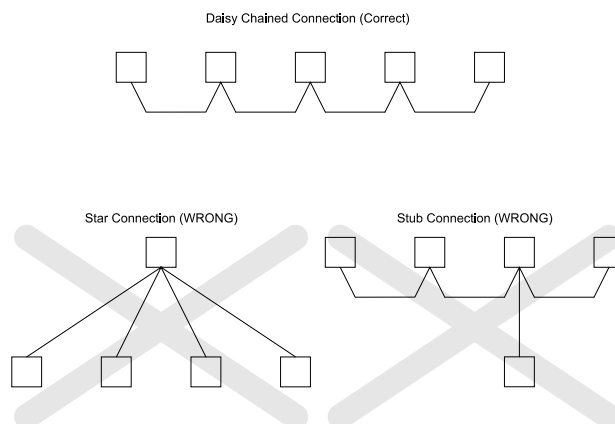

2.3 A and B terminals

The A and B connections to the Integra, INT-12XX digital power measurement meter product can be identified by the signals present on them whilst there is activity on the RS485 bus:

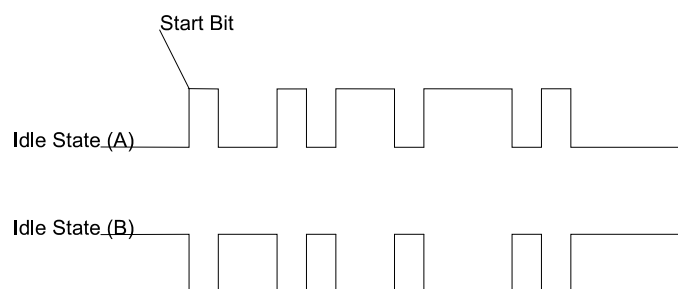

2.4 Troubleshooting

- Start with a simple network, one master and one slave. With Integra, INT-12XX digital power measurement meter products this is easily achieved as the network can be left intact whilst individual instruments are disconnected by removing the RS485 connection from the rear of the instrument.
- Check that the network is connected together correctly. That is all of the “A’s” are connected together, and all of the “B’s” are connected together, and also that all of the “Gnd’s” are connected together.
- Confirm that the data “transmitted” onto the RS485 is not echoed back to the PC on the RS232 lines. (This facility is sometimes a link option within the converter). Many PC based packages seem to not perform well when they receive an echo of the message they are transmitting. SpecView and PCView (PC software) with a RS232 to RS485 converter are believed to include this feature.
- Confirm that the Address of the instrument is the same as the “master” is expecting.
- If the “network” operates with one instrument but not more than one check that each instrument has a unique address.
- Each request for data must be restricted to 50 parameters. Violating this requirement will impact the performance of the instrument and may result in a response time in excess of the specification.
- Check that the MODBUS™ Protocol mode (RTU or ASCII) and serial parameters (baud rate, number of data bits, number of stop bits and parity) are the same for all devices on the network.
- Check that the “master” is requesting floating-point variables (pairs of registers placed on floating point boundaries) and is not “splitting” floating point variables.
- Check that the floating-point byte order expected by the “master” is the same as that used by Integra, INT-12XX digital power measurement meter products. (PCView and Citect packages can use a number of formats including that supported by Integra, INT-12XX digital power measurement meter).
- If possible obtain a second RS232 to RS485 converter and connect it between the RS485 bus and an additional PC equipped with a software package, which can display the data on the bus. Check for the existence of valid requests.

3 MODBUS™ Protocol General Information

Communication on a MODBUS™ Protocol Network is initiated (started) by a “Master” sending a query to a “Slave”. The “Slave”, which is constantly monitoring the network for queries addressed to it, will respond by performing the requested action and sending a response back to the “Master”. Only the “Master” can initiate a query.

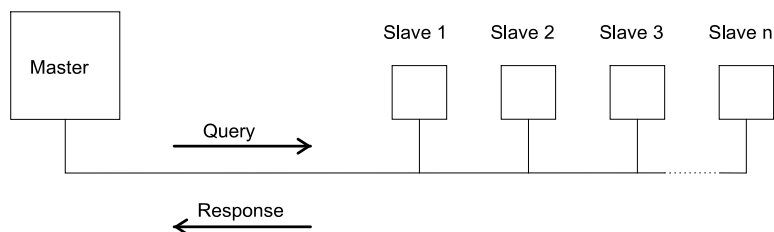

In the MODBUS™ Protocol the master can address individual slaves, or, using a special “Broadcast” address, can initiate a broadcast message to all slaves. The Integra, INT-12XX digital power measurement meter does not support the broadcast address.

3.1 MODBUS™ Protocol Message Format

The MODBUS™ Protocol defines the format for the master’s query and the slave’s response.

The query contains the device (or broadcast) address, a function code defining the requested action, any data to be sent, and an error-checking field.

The response contains fields confirming the action taken, any data to be returned, and an error-checking field. If an error occurred in receipt of the message then the message is ignored, if the slave is unable to perform the requested action, then it will construct an error message and send it as its response.

The MODBUS™ Protocol functions used by the Integra, INT-12XX digital power measurement meter copy 16 bit register values between master and slaves. However, the data used by the Integra, INT-12XX digital power measurement meter is in 32 bit IEEE 754 floating point format. Thus each instrument parameter is conceptually held in two adjacent MODBUS™ Protocol registers.

Query

The following example illustrates a request for a single floating point parameter i.e. two 16-bit Modbus™ Protocol Registers.

First Byte							Last Byte
Slave Address	Function Code	Start Address (Hi)	Start Address (Lo)	Number of Points (Hi)	Number of Points (Lo)	Error Check (Lo)	Error Check (Hi)

Slave Address: 8-bit value representing the slave being addressed (1 to 247), 0 is reserved for the broadcast address. The Integra, INT-12XX digital power measurement meter do not support the broadcast address.

Function Code: 8-bit value telling the addressed slave what action is to be performed. (3, 4, 8 or 16 are valid for Integra, INT-12XX digital power measurement meter)

Start Address (Hi): The top (most significant) eight bits of a 16-bit number specifying the start address of the data being requested.

Start Address (Lo): The bottom (least significant) eight bits of a 16-bit number specifying the start address of the data being requested. As registers are used in pairs and start at zero, then this must be an even number.

Number of Points (Hi): The top (most significant) eight bits of a 16-bit number specifying the number of registers being requested.

Number of Points (Lo): The bottom (least significant) eight bits of a 16-bit number specifying the number of registers being requested. As registers are used in pairs, then this must be an even number.

Error Check (Lo): The bottom (least significant) eight bits of a 16-bit number representing the error check value.

Error Check (Hi): The top (most significant) eight bits of a 16-bit number representing the error check value.

Response

The example illustrates the normal response to a request for a single floating point parameter i.e. two 16-bit Modbus™ Protocol Registers.

First Byte							Last Byte	
Slave Address	Function Code	Byte Count	First Register (Hi)	First Register (Lo)	Second Register (Hi)	Second Register (Lo)	Error Check (Lo)	Error Check (Hi)

- Slave Address: 8-bit value representing the address of slave that is responding.
- Function Code: 8-bit value which, when a copy of the function code in the query, indicates that the slave recognised the query and has responded. (See also Exception Response).
- Byte Count: 8-bit value indicating the number of data bytes contained within this response
- First Register (Hi)*: The top (most significant) eight bits of a 16-bit number representing the first register requested in the query.
- First Register (Lo)*: The bottom (least significant) eight bits of a 16-bit number representing the first register requested in the query.
- Second Register (Hi)*: The top (most significant) eight bits of a 16-bit number representing the second register requested in the query.
- Second Register (Lo)*: The bottom (least significant) eight bits of a 16-bit number representing the second register requested in the query.
- Error Check (Lo): The bottom (least significant) eight bits of a 16-bit number representing the error check value.
- Error Check (Hi): The top (most significant) eight bits of a 16-bit number representing the error check value.

* These four bytes together give the value of the floating point parameter requested.

Exception Response

If an error is detected in the content of the query (excluding parity errors and Error Check mismatch), then an error response (called an exception response), will be sent to the master. The exception response is identified by the function code being a copy of the query function code but with the most-significant bit set. The data contained in an exception response is a single byte error code.

First Byte		Last Byte		
Slave Address	Function Code	Error Code	Error Check (Lo)	Error Check (Hi)

- Slave Address: 8-bit value representing the address of slave that is responding.
- Function Code: 8 bit value which is the function code in the query OR'ed with 80 hex, indicating that the slave either does not recognise the query or could not carry out the action requested.
- Error Code: 8-bit value indicating the nature of the exception detected. (See "Table Of Exception Codes" later).
- Error Check (Lo): The bottom (least significant) eight bits of a 16-bit number representing the error check value.
- Error Check (Hi): The top (most significant) eight bits of a 16-bit number representing the error check value.

3.2 Serial Transmission Modes

There are two MODBUS™ Protocol serial transmission modes, ASCII and RTU. Integra, INT-12XX digital power measurement meter does not support the ASCII mode.

In RTU (Remote Terminal Unit) mode, each 8-bit byte is used in the full binary range and is not limited to ASCII characters as in ASCII Mode. The greater data density allows better data throughput for the same

baud rate, however each message must be transmitted in a continuous stream. This is very unlikely to be a problem for modern communications equipment.

The format for each byte in RTU mode is:

Coding System:	Full 8-bit binary per byte. In this document, the value of each byte will be shown as two hexadecimal characters each in the range 0-9 or A-F.
Line Protocol:	1 start bit, followed by the 8 data bits. The 8 data bits are sent with least significant bit first.
User Option Of Parity And Stop Bits:	No Parity and 2 Stop Bits Even Parity and 1 Stop Bit. Odd Parity and 1 Stop Bit.
User Option of Baud Rate:	9600 ; 19200 ; 38400

The baud rate, parity and stop bits must be selected to match the master's settings.

3.3 MODBUS™ Protocol Message Timing (RTU Mode)

A MODBUS™ Protocol message has defined beginning and ending points. The receiving devices recognises the start of the message, reads the "Slave Address" to determine if they are being addressed and knowing when the message is completed they can use the Error Check bytes and parity bits to confirm the integrity of the message. If the Error Check or parity fails then the message is discarded.

In RTU mode, messages starts with a silent interval of at least 3.5 character times.

The first byte of a message is then transmitted, the device address.

Master and slave devices monitor the network continuously, including during the 'silent' intervals. When the first byte (the address byte) is received, each device checks it to find out if it is the addressed device. If the device determines that it is the one being addressed it records the whole message and acts accordingly, if it is not being addressed it continues monitoring for the next message.

Following the last transmitted byte, a silent interval of at least 3.5 character times marks the end of the message. A new message can begin after this interval.

The entire message must be transmitted as a continuous stream. If a silent interval of more than 1.5 character times occurs before completion of the message, the receiving device flushes the incomplete message and assumes that the next byte will be the address byte of a new message.

Similarly, if a new message begins earlier than 3.5 character times following a previous message, the receiving device may consider it a continuation of the previous message. This will result in an error, as the value in the final CRC field will not be valid for the combined messages.

3.4 How Characters are Transmitted Serially

When messages are transmitted on standard MODBUS™ Protocol serial networks each byte is sent in this order (left to right):

Transmit Character = Start Bit + Data Byte + Parity Bit + 1 Stop Bit (11 bits total):

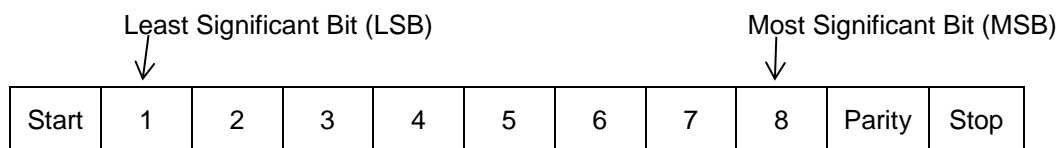

Transmit Character = Start Bit + Data Byte + 2 Stop Bits (11 bits total):

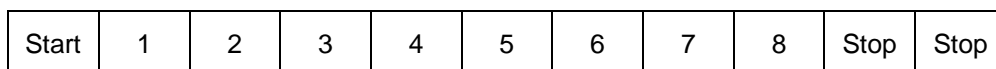

Integra, INT-12XX digital power measurement meter additionally support No parity, One stop bit.

Transmit Character = Start Bit + Data Byte + 1 Stop Bit (10 bits total):

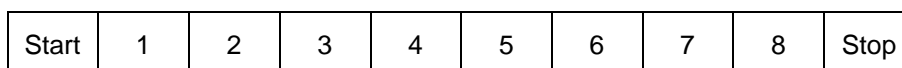

The master is configured by the user to wait for a predetermined timeout interval. The master will wait for this period of time before deciding that the slave is not going to respond and that the transaction should be aborted. Care must be taken when determining the timeout period from both the master and the slaves' specifications. The slave may define the 'response time' as being the period from the receipt of the last bit of the query to the transmission of the first bit of the response. The master may define the 'response time' as period between transmitting the first bit of the query to the receipt of the last bit of the response. It can be seen that message transmission time, which is a function of the baud rate, must be included in the timeout calculation.

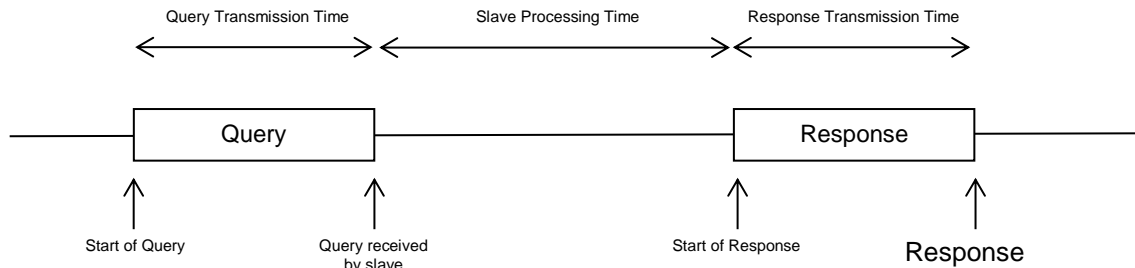

3.5 Error Checking Methods

Standard MODBUS™ Protocol serial networks use two error checking processes, the error check bytes mentioned above check message integrity whilst Parity checking (even or odd) can be applied to each byte in the message.

3.5.1 Parity Checking

If parity checking is enabled – by selecting either Even or Odd Parity - the quantity of “1’s” will be counted in the data portion of each transmit character. The parity bit will then be set to a 0 or 1 to result in an Even or Odd total of “1’s”.

Note that parity checking can only detect an error if an odd number of bits are picked up or dropped in a transmit character during transmission, if for example two 1’s are corrupted to 0’s the parity check will not find the error.

If No Parity checking is specified, no parity bit is transmitted and no parity check can be made. Also, if No Parity checking is specified and one stop bit is selected the transmit character is effectively shortened by one bit.

3.5.2 CRC Checking

The error check bytes of the MODBUS™ Protocol messages contain a Cyclical Redundancy Check (CRC) value that is used to check the content of the entire message. The error check bytes must always be present to comply with the MODBUS™ Protocol, there is no option to disable it.

The error check bytes represent a 16-bit binary value, calculated by the transmitting device. The receiving device must recalculate the CRC during receipt of the message and compare the calculated value to the value received in the error check bytes. If the two values are not equal, the message should be discarded. The error check calculation is started by first pre-loading a 16-bit register to all 1’s (i.e. Hex (FFFF)) each successive 8-bit byte of the message is applied to the current contents of the register. Note: only the eight bits of data in each transmit character are used for generating the CRC, start bits, stop bits and the parity bit, if one is used, are not included in the error check bytes.

During generation of the error check bytes, each 8-bit message byte is exclusive OR’ed with the lower half of the 16 bit register. The register is then shifted eight times in the direction of the least significant bit (LSB), with a zero filled into the most significant bit (MSB) position. After each shift the LSB prior to the shift is extracted and examined. If the LSB was a 1, the register is then exclusive OR’ed with a pre-set, fixed value. If the LSB was a 0, no exclusive OR takes place.

This process is repeated until all eight shifts have been performed. After the last shift, the next 8-bit message byte is exclusive OR’ed with the lower half of the 16 bit register, and the process repeated. The final contents of the register, after all the bytes of the message have been applied, is the error check value.

3.6 Function Codes

The function code part of a MODBUS™ Protocol message defines the action to be taken by the slave. Integra, INT-12XX digital power measurement meter supports the following function codes:

Code	MODBUS™ Protocol name	Description
03	Read Holding Registers	Read the contents of read/write location (4X references)
08	Diagnostics	Only sub-function zero is supported. This returns the data element of the query unchanged.
16 (10h)	Pre-set Multiple Registers	Set the contents of read/write location (4X references)

3.7 IEEE floating point format

The MODBUS™ Protocol defines 16 bit “Registers” for the data variables. A 16-bit number would prove too restrictive, for energy parameters for example, as the maximum range of a 16-bit number is 65535.

However, there are a number of approaches that have been adopted to overcome this restriction. Integra, INT-12XX digital power measurement meter use two consecutive registers to represent a floating-point number, effectively expanding the range to +/- 1x10³⁷.

The values produced by Integra, INT-12XX digital power measurement meter can be used directly without any requirement to “scale” the values, for example, the units for the voltage parameters are volts, the units for the power parameters are watts etc.

What is a floating point Number?

A floating-point number is a number with two parts, a mantissa and an exponent and is written in the form 1.234 x 10⁵. The mantissa (1.234 in this example) must have the decimal point moved to the right with the number of places determined by the exponent (5 places in this example) i.e. 1.234x 10⁵ = 123400. If the exponent is negative the decimal point is moved to the left.

What is an IEEE 754 format floating-point number?

An IEEE 754 floating point number is the binary equivalent of the decimal floating-point number shown above. The major difference being that the most significant bit of the mantissa is always arranged to be 1 and is thus not needed in the representation of the number. The process by which the most significant bit is arranged to be 1 is called normalisation, the mantissa is thus referred to as a “normal mantissa”. During normalisation the bits in the mantissa are shifted to the left whilst the exponent is decremented until the most significant bit of the mantissa is one. In the special case where the number is zero both mantissa and exponent are zero.

The bits in an IEEE 754 format have the following significance:

Data Hi Reg, Hi Byte.	Data Hi Reg, Lo Byte.	Data Lo Reg, Hi Byte.	Data Lo Reg, Lo Byte.
SEEE	EMMM	MMMM	MMMM
EEEE	MMMM	MMMM	MMMM

Where:

S represents the sign bit where 1 is negative and 0 is positive

E is the 8-bit exponent with an offset of 127 i.e. an exponent of zero is represented by 127, an exponent of 1 by 128 etc.

M is the 23-bit normal mantissa. The 24th bit is always 1 and, therefore, is not stored.

Using the above format the floating point number 240.5 is represented as 43708000 hex:

Data Hi Reg, Hi Byte	Data Hi Reg, Lo Byte	Data Lo Reg, Hi Byte	Data Lo Reg, Lo Byte
43	70	80	00

The following example demonstrates how to convert IEEE 754 floating-point numbers from their hexadecimal form to decimal form. For this example, we will use the value for 240.5 shown above

Note that the floating-point storage representation is not an intuitive format. To convert this value to decimal, the bits should be separated as specified in the floating-point number storage format table shown above.

For example:

Data Hi Reg, Hi Byte	Data Hi Reg, Lo Byte	Data Lo Reg, Hi Byte	Data Lo Reg, Lo Byte
0100 0011	0111 0000	1000 0000	0000 0000

From this you can determine the following information.

- The sign bit is 0, indicating a positive number.
- The exponent value is 10000110 binary or 134 decimal. Subtracting 127 from 134 leaves 7, which is the actual exponent.
- The mantissa appears as the binary number 111000010000000000000000

There is an implied binary point at the left of the mantissa that is always preceded by a 1. This bit is not stored in the hexadecimal representation of the floating-point number. Adding 1 and the binary point to the beginning of the mantissa gives the following:

1.111000010000000000000000

Now, we adjust the mantissa for the exponent. A negative exponent moves the binary point to the left. A positive exponent moves the binary point to the right. Because the exponent is 7, the mantissa is adjusted as follows:

11110000.1000000000000000

Finally, we have a binary floating-point number. Binary bits that are to the left of the binary point represent the power of two corresponding to their position. For example, 11110000 represents $(1 \times 2^7) + (1 \times 2^6) + (1 \times 2^5) + (1 \times 2^4) + (0 \times 2^3) + (0 \times 2^2) + (0 \times 2^1) + (0 \times 2^0) = 240$.

Binary bits that are to the right of the binary point also represent a power of 2 corresponding to their position. As the digits are to the right of the binary point the powers are negative. For example: .100 represents $(1 \times 2^{-1}) + (0 \times 2^{-2}) + (0 \times 2^{-3}) + \dots$ which equals 0.5.

Adding these two numbers together and making reference to the sign bit produces the number +240.5.

For each floating point value requested two MODBUS™ Protocol registers (four bytes) must be requested. The received order and significance of these four bytes for Integra, INT-12XX digital power measurement meter is shown below:

Data Hi Reg, Hi Byte	Data Hi Reg, Lo Byte	Data Lo Reg, Hi Byte	Data Lo Reg, Lo Byte
-------------------------	-------------------------	-------------------------	-------------------------

3.8 MODBUS™ Protocol Commands supported

All Integra, INT-12XX digital power measurement meters support the “Read Holding Register” (4X registers) and the “Pre-set Multiple Registers” (write 4X registers) commands of the MODBUS™ Protocol RTU protocol. All values stored and returned are in floating point format to IEEE 754 with the most significant register first.

3.9 Holding Registers

3.9.1 Read Holding Registers

MODBUS™ Protocol code 03 reads the contents of the 4X registers.

Example

The following query will request the V L1-N:

Field Name	Example (Hex)
Slave Address	01
Function	03
Starting Address High	00
Starting Address Low	00
Number of Points High	00
Number of Points Low	02
Error Check Low	C4
Error Check High	0B

Note: Data must be requested in register pairs i.e. the “Starting Address” and the “Number of Points” must be even numbers to request a floating point variable. If the “Starting Address” or the “Number of points” is odd then the query will fall in the middle of a floating point variable the product will return an error message.

The following response returns the contents of V L1-N, But see also “Exception Response” later.

Field Name	Example (Hex)
Slave Address	01
Function	03
Byte Count	04
Data, High Reg, High Byte	00
Data, High Reg, Low Byte	00
Data, Low Reg, High Byte	00
Data, Low Reg, Low Byte	E6
Error Check Low	F7
Error Check High	CF

3.9.2 Write Holding Registers

MODBUS™ Protocol code 16 (160h hex) writes the contents of the 4X registers.

Example

The following query will set the Write Enable register to 0000 00A5 (hex), which enables writing to other registers. Writing remains enabled until this value is changed or the power supply is removed.

Field Name	Example (Hex)
Slave Address	01
Function	10
Starting Address High	02
Starting Address Low	00
Number of Registers High	00
Number of Registers Low	02
Byte Count	04
Data, High Reg, High Byte	00
Data, High Reg, Low Byte	00
Data, Low Reg, High Byte	00
Data, Low Reg, Low Byte	A5
Error Check Low	67
Error Check High	D5

Note: Data must be written in register pairs i.e. the “Starting Address” and the “Number of Points” must be even numbers to write a floating point variable. If the “Starting Address” or the “Number of points” is odd then the query will fall in the middle of a floating point variable the product will return an error message. In general only one floating point value can be written per query

The following response indicates that the write has been successful. But see also “Exception Response” later.

Field Name	Example (Hex)
Slave Address	01
Function	10
Starting Address High	00
Starting Address Low	02
Number of Registers High	00
Number of Registers Low	02
Error Check Low	E0
Error Check High	08

3.10 Exception Response

If the slave in the “Write Holding Register” example above, did not support that function then it would have replied with an Exception Response as shown below. The exception function code is the original function code from the query with the MSB set i.e. it has had 80 hex logically ORed with it. The exception code

indicates the reason for the exception. The slave will not respond at all if there is an error with the parity or CRC of the query. However, if the slave can not process the query then it will respond with an exception. In this case a code 01, the requested function is not support by this slave.

Field Name	Example (Hex)
Slave Address	01
Function	10 OR 80 = 90
Exception Code	01
Error Check Low	8D
Error Check High	C0

3.11 Exception Codes

3.11.1 Table of Exception Codes

Integra, INT-12XX digital power measurement meters support the following exception codes:

Exception Code	MODBUS™ Protocol name	Description
01	Illegal Function	The function code is not supported by the product OR Writing not enabled
02	Illegal Data Address	Attempt to access an invalid address
03	Illegal Data Value	Attempt to set a floating point variable to an invalid value

While TE has made every reasonable effort to ensure the accuracy of the information in this catalogue, TE does not guarantee that it is error-free, nor does TE make any other representation, warranty or guarantee that the information is accurate, correct, reliable or current. TE reserves the right to make any adjustments to the information contained herein at any time without notice. TE expressly disclaims all implied warranties regarding the information contained herein, including, but not limited to, any implied warranties of merchantability or fitness for a particular purpose. The dimensions in this catalogue are for reference purposes only and are subject to change without notice. Specifications are subject to change without notice. Consult TE for the latest dimensions and design specifications. TE connectivity (logo), TE (logo) and TE Connectivity are trademarks of the TE Connectivity Ltd. family of companies. Crompton is a trademark of Crompton Parkinson and is used by TE Connectivity under a licence. Other logos, product and company names mentioned herein may be trademarks of their respective owners

TE Energy – innovative and economical solutions for the electrical power industry: cable accessories, connectors & fittings, insulators & insulation, surge arresters, switching equipment, street lighting, power measurement and control.

Tyco Electronics UK Ltd
 TE Energy
 Freebournes Road
 Witham, Essex CM8 3AH
 Phone: +44 (0)870 870 7500
 Fax: +44 (0)870 240 5287

Email: Crompton.info@te.com
www.crompton-instruments.com



4 APPENDIX 1 - INTEGRA, INT-12XX MODBUS™ Input Register Parameters

Parameter Number	Address	Register	Parameter Units	Parameter Name	Parameter Description	Modbus™ Start Address (Hex)		3P4 W	3P3 W	1P3 W	1P2 W
						Hi Byte	Lo Byte				
1	30001	30000	Volts	V1	Phase 1 line to neutral voltage.	00	00	Yes	Yes	Yes	Yes
2	30003	30002	Volts	V2	Phase 2 line to neutral voltage.	00	02	Yes	Yes	No	No
3	30005	30004	Volts	V3	Phase 3 line to neutral voltage.	00	04	Yes	Yes	No	No
4	30007	30006	Amps	A1	Line 1 current.	00	06	Yes	Yes	Yes	Yes
5	30009	30008	Amps	A2	Line 2 current.	00	08	Yes	Yes	No	No
6	30011	30010	Amps	A3	Line 3 current.	00	0A	Yes	Yes	No	No
7	30013	30012	Watts	P1	Phase 1 power.	00	0C	Yes	No	Yes	Yes
8	30015	30014	Watts	P2	Phase 2 power.	00	0E	Yes	No	No	No
9	30017	30016	Watts	P3	Phase 3 power.	00	10	Yes	No	No	No
10	30019	30018	VA	VA1	Phase 1 VA.	00	12	Yes	No	Yes	Yes
11	30021	30020	VA	VA2	Phase 2 VA.	00	14	Yes	No	No	No
12	30023	30022	VA	VA3	Phase 3 VA.	00	16	Yes	No	No	No
13	30025	30024	VAr	VAr1	Phase 1 VAr.	00	18	Yes	No	Yes	Yes
14	30027	30026	VAr	VAr2	Phase 2 VAr.	00	1A	Yes	No	No	No
15	30029	30028	VAr	VAr3	Phase 3 VAr.	00	1C	Yes	No	No	No
16	30031	30030	None	PF1	Phase 1 power factor.	00	1E	Yes	No	Yes	Yes
17	30033	30032	None	PF2	Phase 2 power factor.	00	20	Yes	No	No	No
18	30035	30034	None	PF3	Phase 3 power factor.	00	22	Yes	No	No	No
19	30037	30036	Degrees	PA1	Phase 1 phase angle.	00	24	Yes	No	Yes	Yes
20	30039	30038	Degrees	PA2	Phase 2 phase angle.	00	26	Yes	No	No	No
21	30041	30040	Degrees	PA3	Phase 3 phase angle.	00	28	Yes	No	No	No
22	30043	30042	Volts	VLNAvg	Average line to neutral voltage.	00	2A	Yes	Yes	Yes	Yes
23	30045	30044	--	--	--	--	--	--	--	--	--
24	30047	30046	Amps	AAvg	Average line current.	00	2E	Yes	Yes	Yes	Yes
25	30049	30048	Amps	ASum	Sum of line currents.	00	30	Yes	Yes	Yes	Yes
26	30051	30050	--	--	--	--	--	--	--	--	--
27	30053	30052	Watts	PSum	Sum of phase powers.	00	34	Yes	Yes	Yes	Yes
28	30055	30054	--	--	--	--	--	--	--	--	--
29	30057	30056	VA	VASum	Sum of phase VAs.	00	38	Yes	Yes	Yes	Yes
30	30059	30058	--	--	--	--	--	--	--	--	--

31	30061	30060	VAr	VArSum	Sum of phase VArS.	00	3C	Yes	Yes	Yes	Yes
32	30063	30062	None	PFTot	Total system power factor.	00	3E	Yes	Yes	Yes	Yes
33	30065	30064	--	--	--	--	--	--	--	--	--
34	30067	30066	Degrees	PATot	Total system phase angle.	00	42	Yes	Yes	Yes	Yes
35	30069	30068	--	--	--	--	--	--	--	--	--
36	30071	30070	Hz	Frq	System frequency.	00	46	Yes	Yes	Yes	Yes
37	30073	30072	Watt Hours	ImpWh	Import Watt hours.	00	48	Yes	Yes	Yes	Yes
38	30075	30074	Watt Hours	ExpWh	Export Watt hours.	00	4A	Yes	Yes	Yes	Yes
39	30077	30076	VAr Hours	ImpVArh	Import VAr hours.	00	4C	Yes	Yes	Yes	Yes
40	30079	30078	VAr Hours	ExpVArh	Export VAr hours.	00	4E	Yes	Yes	Yes	Yes
41	30081	30080	VA Hours	VAh	VA hours.	00	50	Yes	Yes	Yes	Yes
42	30083	30082	A Hours	ASumh	Current sum hours.	00	52				
43	30085	30084	Watts	PSumDmd	Import power sum demand.	00	54	Yes	Yes	Yes	Yes
44	30087	30086	Watts	PSumDmdMax	Maximum import power sum demand.	00	56	Yes	Yes	Yes	Yes
45	30089	30088	Pulse Count	PCnt1	Input pulse count 1	00	58	Yes	Yes	Yes	Yes
	29999	29998	--	--	--	--	--	--	--	--	--
46	30091	30090	Pulse Count	PCnt2	Input pulse count 2	00	5A	Yes	Yes	Yes	Yes
	29999	29998	--	--	--	--	--	--	--	--	--
47	30093	30092	--	--	--	--	--	--	--	--	--
48	30095	30094	--	--	--	--	--	--	--	--	--
49	30097	30096	--	--	--	--	--	--	--	--	--
50	30099	30098	--	--	--	--	--	--	--	--	--
51	30101	30100	VA	VASumDmd	VA sum demand.	00	64	Yes	Yes	Yes	Yes
52	30103	30102	VA	VASumDmdMax	Maximum VA sum demand.	00	66	Yes	Yes	Yes	Yes
53	30105	30104	Amps	ASumDmd	Current sum demand.	00	68	Yes	Yes	Yes	Yes
54	30107	30106	Amps	ASumDmdMax	Maximum current sum demand.	00	6A	Yes	Yes	Yes	Yes
55	30109	30108	Volts	V1Max	Maximum phase 1 line to neutral voltage.	00	6C	Yes	Yes	Yes	Yes
56	30111	30110	Volts	V1Min	Minimum phase 1 line to neutral voltage.	00	6E	Yes	Yes	Yes	Yes
57	30113	30112	Volts	V2Max	Maximum phase 2 line to neutral voltage.	00	70	Yes	Yes	No	No
58	30115	30114	Volts	V2Min	Minimum phase 2 line to neutral voltage.	00	72	Yes	Yes	No	No
59	30117	30116	Volts	V3Max	Maximum phase 3 line to neutral voltage.	00	74	Yes	Yes	No	No
60	30119	30118	Volts	V3Min	Minimum phase 3 line to neutral voltage.	00	76	Yes	Yes	No	No

61	30121	30120	Amps	A1Max	Maximum line 1 current.	00	78	Yes	Yes	Yes	Yes
62	30123	30122	Amps	A1Min	Minimum line 1 current.	00	7A	Yes	Yes	Yes	Yes
63	30125	30124	Amps	A2Max	Maximum line 2 current.	00	7C	Yes	Yes	Yes	No
64	30127	30126	Amps	A2Min	Minimum line 2 current.	00	7E	Yes	Yes	Yes	No
65	30129	30128	Amps	A3Max	Maximum line 3 current.	00	80	Yes	Yes	No	No
66	30131	30130	Amps	A3Min	Minimum line 3 current.	00	82	Yes	Yes	No	No
67	30133	30132	Volts	VLNAvgMax	Maximum average line to neutral voltage.	00	84	Yes	Yes	Yes	Yes
68	30135	30134	Volts	VLNAvgMin	Minimum average line to neutral voltage.	00	86	Yes	Yes	Yes	Yes
69	30137	30136	--	--	--	--	--	--	--	--	--
70	30139	30138	--	--	--	--	--	--	--	--	--
71	30141	30140	Amps	AAvgMax	Maximum average line current.	00	8C	Yes	Yes	Yes	Yes
72	30143	30142	Amps	AAvgMin	Minimum average line current.	00	8E	Yes	Yes	Yes	Yes
73	30145	30144	Amps	ASumMax	Maximum sum of line currents.	00	90	Yes	Yes	Yes	Yes
74	30147	30146	Amps	ASumMin	Minimum sum of line currents.	00	92	Yes	Yes	Yes	Yes
75	30149	30148	Watts	P1Max	Maximum phase 1 power.	00	94	Yes	Yes	Yes	Yes
76	30151	30150	Watts	P1Min	Minimum phase 1 power.	00	96	Yes	Yes	Yes	Yes
77	30153	30152	Watts	P2Max	Maximum phase 2 power.	00	98	Yes	Yes	Yes	No
78	30155	30154	Watts	P2Min	Minimum phase 2 power.	00	9A	Yes	Yes	Yes	No
79	30157	30156	Watts	P3Max	Maximum phase 3 power.	00	9C	Yes	Yes	No	No
80	30159	30158	Watts	P3Min	Minimum phase 3 power.	00	9E	Yes	Yes	No	No
81	30161	30160	Watts	PSumMax	Maximum sum of phase powers.	00	A0	Yes	Yes	Yes	Yes
82	30163	30162	Watts	PSumMin	Minimum sum of phase powers.	00	A2	Yes	Yes	Yes	Yes
83	30165	30164	VAr	VAr1Max	Maximum phase 1 VArS.	00	A4	Yes	Yes	Yes	Yes
84	30167	30166	VAr	VAr1Min	Minimum phase 1 VArS.	00	A6	Yes	Yes	Yes	Yes
85	30169	30168	VAr	VAr2Max	Maximum phase 2 VArS.	00	A8	Yes	Yes	Yes	No
86	30171	30170	VAr	VAr2Min	Minimum phase 2 VArS.	00	AA	Yes	Yes	Yes	No
87	30173	30172	VAr	VAr3Max	Maximum phase 3 VArS.	00	AC	Yes	Yes	No	No
88	30175	30174	VAr	VAr3Min	Minimum phase 3 VArS.	00	AE	Yes	Yes	No	No
89	30177	30176	VAr	VArSumMax	Maximum sum of phase VArS.	00	B0	Yes	Yes	Yes	Yes
90	30179	30178	VAr	VArSumMin	Minimum sum of phase VArS.	00	B2	Yes	Yes	Yes	Yes
91	30181	30180	VA	VA1Max	Maximum phase 1 VAs.	00	B4	Yes	Yes	Yes	Yes
92	30183	30182	VA	VA1Min	Minimum phase 1 VAs.	00	B6	Yes	Yes	Yes	Yes
93	30185	30184	VA	VA2Max	Maximum phase 2 VAs.	00	B8	Yes	Yes	Yes	No
94	30187	30186	VA	VA2Min	Minimum phase 2 VAs.	00	BA	Yes	Yes	Yes	No
95	30189	30188	VA	VA3Max	Maximum phase 3 VAs.	00	BC	Yes	Yes	No	No
96	30191	30190	VA	VA3Min	Minimum phase 3 VAs.	00	BE	Yes	Yes	No	No

97	30193	30192	VA	VASumMax	Maximum sum of phase VAs.	00	C0	Yes	Yes	Yes	Yes
98	30195	30194	VA	VASumMin	Minimum sum of phase VAs.	00	C2	Yes	Yes	Yes	Yes
99	30197	30196	Hz	FrqMax	Maximum system voltage frequency.	00	C4	Yes	Yes	Yes	Yes
100	30199	30198	Hz	FrqMin	Minimum system voltage frequency.	00	C6	Yes	Yes	Yes	Yes
101	30201	30200	Volts	V12	Voltage line 1 to line 2.	00	C8	Yes	Yes	Yes	Yes
102	30203	30202	Volts	V23	Voltage line 2 to line 3.	00	CA	Yes	Yes	Yes	No
103	30205	30204	Volts	V31	Voltage line 3 to line 1.	00	CC	Yes	Yes	No	No
104	30207	30206	Volts	VLLAvg	Average line to line voltage.	00	CE	Yes	Yes	Yes	Yes
105	30209	30208	Volts	V12Max	Maximum line 1 to line 2 voltage.	00	D0	Yes	Yes	Yes	Yes
106	30211	30210	Volts	V12Min	Minimum line 1 to line 2 voltage.	00	D2	Yes	Yes	Yes	Yes
107	30213	30212	Volts	V23Max	Maximum line 2 to line 3 voltage.	00	D4	Yes	Yes	Yes	No
108	30215	30214	Volts	V23Min	Minimum line 2 to line 3 voltage.	00	D6	Yes	Yes	Yes	No
109	30217	30216	Volts	V31Max	Maximum line 3 to line 1 voltage.	00	D8	Yes	Yes	No	No
110	30219	30218	Volts	V31Min	Minimum line 3 to line 1 voltage.	00	DA	Yes	Yes	No	No
111	30221	30220	Volts	VLLAvgMax	Maximum average line to line voltage.	00	DC	Yes	Yes	Yes	Yes
112	30223	30222	Volts	VLLAvgMin	Minimum average line to line voltage.	00	DE	Yes	Yes	Yes	Yes
113	30225	30224	Amps	ANeu	Neutral current.	00	00	Yes	Yes	Yes	Yes
114	30227	30226	Amps	ANeuMax	Maximum neutral current.	00	00	Yes	Yes	Yes	Yes
115	30229	30228	Amps	ANeuMin	Minimum neutral current.	00	00	Yes	Yes	Yes	Yes
116	30231	30230	Amps	ANDmd	Neutral current demand	00	00	Yes	Yes	Yes	Yes
117	30233	30232	Amps	ANDmdMax	Maximum neutral current demand	00	00	Yes	Yes	Yes	Yes
118	30235	30234	%	V1THD	Phase 1 line to neutral voltage THD. *	00	EA	Yes	Yes	Yes	Yes
119	30237	30236	%	V2THD	Phase 2 line to neutral voltage THD. *	00	EC	Yes	Yes	Yes	No
120	30239	30238	%	V3THD	Phase 3 line to neutral voltage THD. *	00	EE	Yes	Yes	No	No
121	30241	30240	%	A1THD	Line 1 current THD.	00	F0	Yes	Yes	Yes	Yes
122	30243	30242	%	A2THD	Line 2 current THD.	00	F2	Yes	Yes	Yes	No
123	30245	30244	%	A3THD	Line 3 current THD.	00	F4	Yes	Yes	No	No
124	30247	30246	--	--	--	--	--	--	--	--	--
125	30249	30248	%	VTHDAvg	Average line to neutral voltage THD. *	00	F8	Yes	Yes	Yes	Yes
126	30251	30250	%	ATHDAvg	Average line current THD.	00	FA	Yes	Yes	Yes	Yes
127	30253	30252	centi hours	HRun	Hours run at over minimum load.	00	FC	Yes	Yes	Yes	Yes
128	30255	30254	None	PFTot	Total system power factor, times minus one.	00	FE	Yes	Yes	Yes	Yes
129	30257	30256	--	--	--	--	--	--	--	--	--
130	30259	30258	Amps	A1Dmd	Line 1 current demand.	01	02	Yes	Yes	Yes	Yes
131	30261	30260	Amps	A2Dmd	Line 2 current demand.	01	04	Yes	Yes	Yes	No
132	30263	30262	Amps	A3Dmd	Line 3 current demand.	01	06	Yes	Yes	No	No

133	30265	30264	Amps	A1DmdMax	Maximum line 1 current demand.	01	08	Yes	Yes	Yes	Yes
134	30267	30266	Amps	A2DmdMax	Maximum line 2 current demand.	01	0A	Yes	Yes	Yes	No
135	30269	30268	Amps	A3DmdMax	Maximum line 3 current demand.	01	0C	Yes	Yes	No	No
136	30271	30270	None	PRot	Phase rotation sequence.	01	0E	Yes	Yes	Yes	Yes
137	30273	30272	%	VLNBal	Line to neutral voltage out of balance.	01	10	Yes	Yes	Yes	Yes
138	30275	30274	%	VLLBal	Line to line voltage out of balance.	01	12	Yes	Yes	Yes	Yes
139	30277	30276	%	ABal	Line current out of balance.	01	14	Yes	Yes	Yes	Yes
140	30279	30278	%	VLNBalMax	Maximum line to neutral voltage out of balance.	01	16	Yes	Yes	Yes	Yes
141	30281	30280	%	VLNBalMin	Minimum line to neutral voltage out of balance.	01	18	Yes	Yes	Yes	Yes
142	30283	30282	%	VLLBalMax	Maximum line to line voltage out of balance.	01	1A	Yes	Yes	Yes	Yes
143	30285	30284	%	VLLBalMin	Minimum line to line voltage out of balance.	01	1C	Yes	Yes	Yes	Yes
144	30287	30286	%	ABalMax	Maximum line current out of balance.	01	1E	Yes	Yes	Yes	Yes
145	30289	30288	%	ABalMin	Minimum line current out of balance.	01	20	Yes	Yes	Yes	Yes
146	30291	30290	None	PF1Max	Maximum phase 1 power factor.	01	22	Yes	Yes	Yes	Yes
147	30293	30292	None	PF1Min	Minimum phase 1 power factor.	01	24	Yes	Yes	Yes	Yes
148	30295	30294	None	PF2Max	Maximum phase 2 power factor.	01	26	Yes	Yes	Yes	No
149	30297	30296	None	PF2Min	Minimum phase 2 power factor.	01	28	Yes	Yes	Yes	No
150	30299	30298	None	PF3Max	Maximum phase 3 power factor.	01	2A	Yes	Yes	No	No
151	30301	30300	None	PF3Min	Minimum phase 3 power factor.	01	2C	Yes	Yes	No	No
152	30303	30302	None	PFTotMax	Maximum total system power factor.	01	2E	Yes	Yes	Yes	Yes
153	30305	30304	None	PFTotMin	Minimum total system power factor.	01	30	Yes	Yes	Yes	Yes
154	30307	30306	Degrees	PATotMax	Maximum total system phase angle.	01	32	Yes	Yes	Yes	Yes
155	30309	30308	Degrees	PATotMin	Minimum total system phase angle.	01	34	Yes	Yes	Yes	Yes
156	30311	30310	%	V1THDMax	Maximum phase 1 line to neutral voltage THD. *	01	36	Yes	Yes	Yes	Yes
157	30313	30312	%	V1THDMin	Minimum phase 1 line to neutral voltage THD. *	01	38	Yes	Yes	Yes	Yes
158	30315	30314	%	V2THDMax	Maximum phase 2 line to neutral voltage THD. *	01	3A	Yes	Yes	Yes	No
159	30317	30316	%	V2THDMin	Minimum phase 2 line to neutral voltage THD. *	01	3C	Yes	Yes	Yes	No
160	30319	30318	%	V3THDMax	Maximum phase 3 line to neutral voltage THD. *	01	3E	Yes	Yes	No	No
161	30321	30320	%	V3THDMin	Minimum phase 3 line to neutral voltage THD. *	01	40	Yes	Yes	No	No

162	30323	30322	%	A1THDMax	Maximum line 1 current THD.	01	42	Yes	Yes	Yes	Yes
163	30325	30324	%	A1THDMin	Minimum line 1 current THD.	01	44	Yes	Yes	Yes	Yes
164	30327	30326	%	A2THDMax	Maximum line 2 current THD.	01	46	Yes	Yes	Yes	No
165	30329	30328	%	A2THDMin	Minimum line 2 current THD.	01	48	Yes	Yes	Yes	No
166	30331	30330	%	A3THDMax	Maximum line 3 current THD.	01	4A	Yes	Yes	No	No
167	30333	30332	%	A3THDMin	Minimum line 3 current THD.	01	4C	Yes	Yes	No	No
168	30335	30334	Watts	P1Dmd	Import phase 1 power demand	01	4E	Yes	Yes	Yes	Yes
169	30337	30336	Watts	P2Dmd	Import phase 2 power demand	01	50	Yes	Yes	Yes	No
170	30339	30338	Watts	P3Dmd	Import phase 3 power demand	01	52	Yes	Yes	No	No
171	30341	30340	Watts	P1DmdMax	Import phase 1 power demand maximum	01	54	Yes	Yes	Yes	Yes
172	30343	30342	Watts	P2DmdMax	Import phase 2 power demand maximum	01	56	Yes	Yes	Yes	No
173	30345	30344	Watts	P3DmdMax	Import phase 3 power demand maximum	01	58	Yes	Yes	No	No
174	30347	30346	VA	VA1Dmd	Phase 1 VA demand	01	5A	Yes	Yes	Yes	Yes
175	30349	30348	VA	VA2Dmd	Phase 2 VA demand	01	5C	Yes	Yes	Yes	No
176	30351	30350	VA	VA3Dmd	Phase 3 VA demand	01	5E	Yes	Yes	No	No
177	30353	30352	VA	VA1DmdMax	Phase 1 VA demand maximum	01	60	Yes	Yes	Yes	Yes
178	30355	30354	VA	VA2DmdMax	Phase 2 VA demand maximum	01	62	Yes	Yes	Yes	No
179	30357	30356	VA	VA3DmdMax	Phase 3 VA demand maximum	01	64	Yes	Yes	No	No
180	30359	30358	%	VTHDAvg	Maximum average line to neutral voltage THD. *	01	66	Yes	Yes	Yes	Yes
181	30361	30360	%	VTHDAvg	Minimum average line to neutral voltage THD. *	01	68	Yes	Yes	Yes	Yes
182	30363	30362	%	ATHDAvg	Maximum average line current THD.	01	6A	Yes	Yes	Yes	Yes
183	30365	30364	%	ATHDAvg	Minimum average line current THD.	01	6C	Yes	Yes	Yes	Yes
184	30367	30366	Degrees	PA1Max	Maximum phase 1 phase angle.	01	6E	Yes	Yes	Yes	Yes
185	30369	30368	Degrees	PA2Max	Maximum phase 2 phase angle.	01	70	Yes	Yes	Yes	No
186	30371	30370	Degrees	PA3Max	Maximum phase 3 phase angle.	01	72	Yes	Yes	No	No
187	30373	30372	Degrees	PA1Min	Minimum phase 1 phase angle.	01	74	Yes	Yes	Yes	Yes
188	30375	30374	Degrees	PA2Min	Minimum phase 2 phase angle.	01	76	Yes	Yes	Yes	No
189	30377	30376	Degrees	PA3Min	Minimum phase 3 phase angle.	01	78	Yes	Yes	No	No

5 APPENDIX 2 - INTEGRA, INT-12XX MODBUS™ HOLDING Register Parameters

Parameter Number	Register	Address	Parameter Units	Parameter Name	Parameter Description	Modbus™ Start Address (Hex)		3P4W	3P3W	1P2W	Valid Range	Default	Mode	Restart	Integra 12XX	INT-1630	CI3 /CI5
						Hi	Lo										
1	40001	40000	Minutes		Read - Minutes into first demand calculation.	00	00	Yes	Yes	Yes	0		ro	No	Yes	Yes	Yes
2	40003	40002	Minutes		Write - Demand period in minutes. see SYS_MINUTES_U8DEF for default value.	00	02	Yes	Yes	Yes	0, 5, 8, 10, 15, 20, 30 and 60 minutes. Write demand period: 0-60 minutes. Setting the period to 0 will cause the "Phase # current demand" parameters to show the "Phase # current values" and "Max. phase # current demand" to show the maximum value of the "Phase # current" parameter since last demand reset.	60	r/w	No	Yes	Yes	Yes
3	40005	40004	0,1	Slide Time	Slide Time	00	04	Yes	No	No	Range: 1 to (Demand Period - 1)	1	r/w	No	Yes	--	No
4	40007	40006	None	Demand Calculation Method		00	06	Yes	Yes	Yes	0 = slide time 1 - Fixed Time	0	r/w	No	Yes	Yes	
6	40011	40010	Index	System Type	Write system type 1: 1P2W, 2: 3P3W, 3: 3P4W and 4: 1P3W.	00	0A	Yes	Yes	Yes	Write system type 1: 1P2W, 2: 3P3W and 3: 3P4W	3	r/w	No	Yes	Yes	No
7	40013	40012	milliseconds	Pulse Width 1	Write pulse on period in milliseconds 60ms, 100ms or 200ms.	00	0C	Yes	Yes	Yes	Write pulse on period in milliseconds 60ms, 100ms or 200ms.	200ms	r/w	No	Yes	20ms units	
8	40015	40014	Index	Password Lock	Write- any value to password lock protected registers. Read password lock status: 0 = locked. 1 = Factory password locked, user password unlocked. Write the password to get KPPA unlocked to enable programming of key parameters	00	0E	Yes	Yes	Yes	0: Instrument locked 1: User password entered	0	r/w	No	Yes	--	Yes
9	40017	40016															
10	40019	40018	Index	Network Parity Stop	Read/Write -Read/Write the Network or Axillary ports parity/stop bits. D Read/Write the Network port parity/stop bits from the Display. 0 = One stop bit and no parity, default. 1 = One stop bit and even parity. 2 = One stop bit and odd parity. 3 = Two stop bits	00	12	Yes	Yes	Yes	From Network own parity and stop bits code read/write 0: One stop bit and no parity. 1: One stop bit and even parity. 2: One stop bit and odd parity. 3: Two stop bits and no parity.	0	r/w	Yes	Yes	Yes	Yes

					and no parity. Requires a restart to become effective.												
11	40021	40020	Numerical	Network Node	Read/Write - the node address. Requires a restart to become effective.	00	14	Yes	Yes	Yes	From Network or Option Module port, read/write own node number. 1 to 247: Node number.	1	r/w	Yes	Yes	Yes	Yes
12	40023	40022	Index	Pulse 1 rate	Write- pulse divisor index n, as in Wh/10^n. See SYS_PULSEDIVISOR_U8DEF for default value.	00	16	Yes	Yes	Yes	Write pulse rate index: n = 0 to 6 0- - 0.001 kwh/imp 1--0.01kwh/imp 2--0.1kwh/imp 3--1kwh/imp 4-10kwh/imp 5-100kwh/imp 6-1000kwh/imp	3	r/w	No	Yes	Yes	Yes
13	40025	40024	Numerical	Password	Read/Write- Read password. Write password for access to protected registers.	00	18	Yes	Yes	Yes	Write user password to access parameters.	0	wo	No	Yes	Yes	Yes
15	40029	40028	Index	Network Baud Rate	Read/Write- the Network port baud rate code from the Display. 0 = 2400 baud. 1 = 4800 baud. 2 = 9600 baud, default. 3 = 19200 baud. 4 = 38400 baud, 5 = 1200 baud.	00	1C	Yes	Yes	Yes	From Display port, read/write Network port Baud Rate code. 0: 2400 Baud. 1: 4800 Baud. 2: 9600 Baud. 3: 19200 Baud. 4: 38400 Baud.	2	r/w	Yes	Yes	Yes	Yes
24	40047	40046	Volts	PT1	Primary Voltage	00	2E	Yes	Yes	Yes	Range 100 to 500000	400	r/w	No	Yes	No	No
25	40049	40048	Volts	PT2	Secondary Voltage	00	30	Yes	Yes	Yes	Range 100 to 480	400	r/w	Yes	Yes	No	No
26	40051	40050	Amps	CT1	Primary Current	00	32	Yes	Yes	Yes	Range: 1 to 9999A	5	r/w	Yes	Yes	No	No
27	40053	40052	Amps	CT2	Secondary Current	00	34	Yes	Yes	Yes	Range 1 or 5	5	r/w	Yes	Yes	No	No
29	40057	40056	Numerical		Current Direction correction	00	38	Yes	Yes	Yes	0 = A Frd, B Frd, C Frd 1 = A Rev, B Frd, C Frd 2 = A Frd, B Rev, C Frd 3 = A Rev, B Rev, C Frd 4 = A Frd, B Frd, C Rev 5 = A Rev, B Frd, C Rev 6 = A Frd, B Rev, C Rev 7 = A Rev, B Rev, C Rev	0	r/w	Yes	Yes	No	No
30	40059	40058	Seconds		Automatic Scroll Time	00	3A	Yes	Yes	Yes	Range: 0-255 0 means inactive	0	r/w	No	Yes	No	No
31	40061	40060	Minutes		Backlit Time	00	3C	Yes	Yes	Yes	Range 0-120 0 means backlit always on	0	r/w	No	Yes	No	No
44	40087	40086	Pulse 1 Energy Type	Relay 1 Energy Index	Write - Write Modbus input parameter for pulse relay 1.	00	56	Yes	Yes	Yes	1: import active energy 2: total active energy4: export active energy, default5: import reactive energy6: total reactive energy8: export reactive energy	1	r/w	No	Yes	No	No

109	40217	40216		Reset	Reset Logged Data	00	D8	Yes	Yes	Yes	Write code to reset data group. Code 1 for Energy. Code 2 for Demand Maximums. Code 3 for Demand Maximums and Demand Time		r/w	No	Yes	No	Yes
-----	-------	-------	--	-------	-------------------	----	----	-----	-----	-----	--	--	-----	----	-----	----	-----